

# Conductivity, pH/ORP & Disinfection



## Intuition-6™ Series Water Treatment Controllers

Enjoy unparalleled versatility and a collection of sensors and powerful built-in algorithms for control of chemical metering pumps and valves in a broad range of water treatment applications

### KEY BENEFITS

- Large touchscreen display with icon based programming makes setup easy
- Universal sensor input provides extraordinary flexibility; the same controller can be used with almost any type of sensor needed
- Six relay control outputs
- Combination sensor input & analog input board that adds even more flexibility
- Lead/Lag control of relays
- Optional dual analog (4-20 mA) input for Fluorometers or nearly any other process value
- Multiple language support allows simple setup no matter where your business takes you
- Economical wall-mount package for easy installation
- On-screen and web page graphing of sensor values and control output status
- The Intuition-6™ with amperometric chlorine sensors can be used for reporting chlorine residual measurements in accordance with EPA Method 334.0
- Six virtual inputs and six virtual outputs
- Complete flexibility in the function of each relay
- Email alarm messages, datalogs, graphs, or system summary reports
- Ethernet option for remote access via the Internet, LAN, BACnet or Modbus/TCP



**W A L C H E M**

**IWAKI America Inc.**

# SPECIFICATIONS

## MEASUREMENT PERFORMANCE

	Range	Resolution	Accuracy
0.01 Cell Contacting Conductivity	0-300 $\mu\text{S}/\text{cm}$	0.01 $\mu\text{S}/\text{cm}$ , 0.0001 mS/cm, 0.001 mS/m, 0.0001 S/m, 0.01 ppm	$\pm 1\%$ of reading
0.1 Cell Contacting Conductivity	0-3,000 $\mu\text{S}/\text{cm}$	0.1 $\mu\text{S}/\text{cm}$ , 0.0001 mS/cm, 0.01 mS/m, 0.0001 S/m, 0.1 ppm	$\pm 1\%$ of reading
1.0 Cell Contacting Conductivity	0-30,000 $\mu\text{S}/\text{cm}$	1 $\mu\text{S}/\text{cm}$ , 0.001 mS/cm, 0.1 mS/m, 0.0001 S/m, 1 ppm	$\pm 1\%$ of reading
10.0 Cell Contacting Conductivity	0-300,000 $\mu\text{S}/\text{cm}$	10 $\mu\text{S}/\text{cm}$ , 0.01 mS/cm, 1 mS/m, 0.001 S/m, 10 ppm	$\pm 1\%$ of reading
pH	-2 to 16 pH units	0.01 pH units	$\pm 0.01\%$ of reading
ORP/Ion Selective Electrode	-1500 to 1500 mV	0.1 mV	$\pm 1$ mV
Disinfection Sensors	-2000 to 1500 mV	0.1 mV	$\pm 1$ mV
	0 - 2 ppm to 0 - 20,000 ppm	Varies with range and slope	Varies with range and slope
Electrodeless Conductivity	500 - 12,000 $\mu\text{S}/\text{cm}$	1 $\mu\text{S}/\text{cm}$ , 0.01 mS/cm, 0.1 mS/m, 0.001 S/m, 1 ppm	$\pm 1\%$ of reading
	3,000-40,000 $\mu\text{S}/\text{cm}$	1 $\mu\text{S}/\text{cm}$ , 0.01 mS/cm, 0.1 mS/m, 0.001 S/m, 1 ppm	$\pm 1\%$ of reading
	10,000-150,000 $\mu\text{S}/\text{cm}$	10 $\mu\text{S}/\text{cm}$ , 0.1 mS/cm, 1 mS/m, 0.01 S/m, 10 ppm	$\pm 1\%$ of reading
	50,000-500,000 $\mu\text{S}/\text{cm}$	10 $\mu\text{S}/\text{cm}$ , 0.1 mS/cm, 1 mS/m, 0.01 S/m, 10 ppm	$\pm 1\%$ of reading
	200,000-2,000,000 $\mu\text{S}/\text{cm}$	100 $\mu\text{S}/\text{cm}$ , 0.1 mS/cm, 1 mS/m, 0.1 S/m, 100 ppm	$\pm 1\%$ of reading
Temperature	23 to 500°F (-5 to 260°C)	0.1°F (0.1°C)	$\pm 1\%$ of reading within range

Temperature°C	Range Multiplier%
0	181.3
10	139.9
15	124.2
20	111.1
25	100.0
30	90.6
35	82.5
40	75.5
50	64.3
60	55.6
70	48.9

Temperature°C	Range Multiplier%
80	43.5
90	39.2
100	35.7
110	32.8
120	30.4
130	28.5
140	26.9
150	25.5
160	24.4
170	23.6
180	22.9

Note: Conductivity ranges above apply at 25°C. At higher temperatures, the range is reduced per the range multiplier chart.



## DIMENSIONS

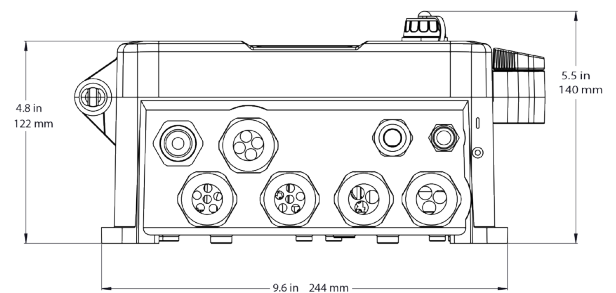
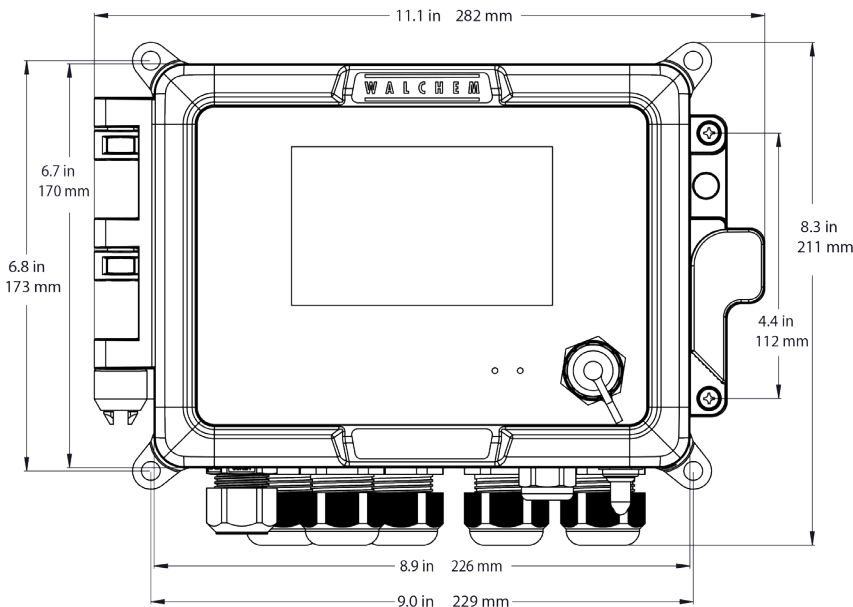

# SPECIFICATIONS

## INPUTS

### Power

100 to 240 VAC +/- 10%, 50 or 60 Hz, 7 A maximum  
Fuse: 6.3 A

### Sensor Input Signals (0, 1 or 2 depending on model code)

Contacting Conductivity: 0.01, 0.1, 1.0, or 10.0 cell constant, or Electrodeless Conductivity (not available on the combination sensor/analog input card) or Disinfection or Amplified pH, ORP, or Ion Selective Electrode which requires a preamplified signal. ±5VDC power available for external preamps. Walchem WEL or WDS series pH/ORP sensors recommended.

Each sensor input card contains a temperature input.  
Temperature: 100 or 1000 ohm RTD, 10K or 100K Thermistor

### Analog (4-20 mA) Sensor Input

#### (0, 1, 2 or 4 depending on model code)

2-wire loop powered and self-powered transmitters supported

3-wire and 4-wire transmitters supported

Each dual sensor input board has two channels:

Channel 1, 130 ohm input resistance and Channel 2, 280 ohm input resistance. The combination input board has one channel, 280 ohm input resistance.

Available Power: One independent isolated 24 VDC ±15% supply per channel. 1.5 W maximum for each channel. 2W (83 mA at 24 VDC) total power consumption for all channels (four total channels possible if two dual boards are installed; 2W is equivalent to 2 Little Dipper sensors)

### Digital Input Signals (6):

#### State-Type Digital Inputs

Electrical: Optically isolated and providing an electrically isolated 9V power with a nominal 2.3mA current when the digital input switch is closed.

Typical response time: < 2 seconds.

Devices supported: Any isolated dry contact (i.e. relay, reed switch).

Types: Interlock

#### Low Speed Counter-Type Digital Inputs

Electrical: Optically isolated and providing an electrically isolated 9V power with a nominal 2.3mA current when the digital input switch is closed, 0-10 Hz, 50 msec minimum width. Devices supported: Any device with isolated open drain, open collector, transistor or reed switch.

Types: Contacting Flowmeter

#### High Speed Counter-Type Digital Inputs

Electrical: Optically isolated and providing an electrically isolated 9V power with a nominal 2.3mA current when the digital input switch is closed, 0-500 Hz, 1.00 msec minimum width. Devices supported: Any device with isolated open drain, open collector, transistor or reed switch.

Types: Paddlewheel Flowmeter

## OUTPUTS

### Powered Mechanical Relays

#### (0 or 6 model code dependent)

Pre-powered on circuit board switching line voltage

All relays are fused together as one group, total current must not exceed 6A (resistive), 1/8 HP (93W)

### Dry Contact Mechanical Relays

#### (0, 2 or 4 model code dependent)

6 A (resistive), 1/8 HP (93W)

Dry contact relays are not fuse protected.

### Pulse Outputs (0, 2 or 4 model code dependent)

Opto-isolated, solid-state relay, 200mA, 40V DC

VLOWMAX = 0.05V @ 18mA

### 4 - 20 mA (0 or 2 model code dependent)

Internally powered, fully isolated

600 Ohm max resistive load

Resolution 0.0015% of span

Accuracy ± 0.5% of reading

### Ethernet

10/100 802.3-2005

Auto MDIX support

Auto Negotiation

### USB

Connector: Type A receptacle

Speed: High speed (480 Mbit)

Power: 0.5 A maximum

## AGENCY CERTIFICATIONS

Safety: UL 61010-1:2012 3rd Ed + Rev:2019  
CSA C22.2 No. 61010-1:2012 3rd Ed. + U1; U2  
IEC 61010-1:2010 3rd Ed. + A1:2016  
EN 61010-1:2010 3rd Ed. + A1:2019  
BS EN 61010-1:2010 + A1:2019

EMC: IEC 61326-1:2020  
EN 61326-1:2013  
BS EN 61326-1:2013

Note: For EN 61000-4-3 Radiated RF Immunity, the controller meets Performance Criteria B.

\*Class A equipment: Equipment suitable for use in establishments other than domestic, and those directly connected to a low voltage 100-240 VAC) power supply network which supplies buildings used for domestic purposes.

## MECHANICAL (CONTROLLER)

Enclosure Material	Polycarbonate
Enclosure Rating	Certified to UL 50 and UL 50E Type 4X. IEC 60529 meets IP66
Environmental Conditions	Can be installed indoors and outdoors. Suitable for wet location
Dimensions	11.1" x 8.3" x 5.5" (282 mm x 211 mm x 140 mm)
Display	5" TFT color display, 800 x 480 pixels with capacitive touchscreen
Operating Ambient Temp	-4 to 131°F (-20 to 55°C)
Storage Temperature	-4 to 176°F (-20 to 80°C)
Humidity	10 to 90% non-condensing
Pollution Degree	2
Overvoltage Category	II
Altitude	2000 m (6560 ft) maximum

# SPECIFICATIONS

## MECHANICAL (SENSORS) (\*see graph)

Sensor	Pressure	Temperature	Materials	Process Connections
Electrodeless Conductivity	0-150 psi (0-10 bar)*	CPVC: 32-158°F (0 to 70°C)* PEEK: 32-190°F (0 to 88°C)	CPVC, FKM in-line o-ring PEEK, 316 SS in-line Adapter	1" NPTM submersion 2" NPTM in-line adapter
pH	0-100 psi (0-7 bar)*	50-158°F (10-70°C)*	CPVC, Glass, FKM o-rings, HDPE, Titanium Rod, glass-filled PP tee	1" NPTM submersion 3/4" NPTF in-line tee
ORP	0-100 psi (0-7bar)*	32-158°F (0-70°C)*		
Contacting Conductivity (Condensate)	0-200 psi (0-14 bar)	32-248°F (0-120°C)	316SS, PEEK	3/4" NPTM
Contacting Conductivity Graphite (Cooling Tower)	0-150 psi (0-10 bar)*	32-158°F (0-70°C)*	Graphite, Glass-filled PP, FKM o-ring	3/4" NPTM
Contacting Conductivity SS (Cooling Tower)	0-150 psi (0-10 bar)*	32-158°F (0-70°C)*	316SS, Glass-filled PP, FKM o-ring	3/4" NPTM
Contacting Conductivity (Boiler)	0-250 psi (0-17 bar)	32-401°F (0-205°C)	316SS, PEEK	3/4" NPTM
Contacting Conductivity (High Pressure Tower)	0-300 psi (0-21 bar)*	32-158°F (0-70°C)*	316SS, PEEK	3/4" NPTM
pH (High Pressure)	0-300 psi (0-21 bar)*	32-275°F (0-135°C)*	Glass, Polymer, PTFE, 316SS, FKM	1/2" NPTM gland
ORP (High Pressure)	0-300 psi (0-21 bar)*	32-275°F (0-135°C)*	Platinum, Polymer, PTFE, 316SS, FKM	1/2" NPTM gland
Free Chlorine/Bromine	0-14.7 psi (0-1 bar)	32-113°F (0-45°C)	PVC, Polycarbonate, Silicone Rubber, SS, PEEK, FKM, Isoplast	1/4" NPTF Inlet 3/4" NPTF Outlet
Extended pH Range Free Chlorine/Bromine	0-14.7 psi (0-1 bar)	32-113°F (0-45°C)		
Total Chlorine	0-14.7 psi (0-1 bar)	32-113°F (0-45°C)		
Chlorine Dioxide	0-14.7 psi (0-1 bar)	32-131°F (0-55°C)		
Ozone	0-14.7 psi (0-1 bar)	32-131°F (0-55°C)		
Peracetic Acid	0-14.7 psi (0-1 bar)	32-131°F (0-55°C)		
Hydrogen Peroxide	0-14.7 psi (0-1 bar)	32-113°F (0-45°C)		
Flow Switch Manifold	0-150 psi (0-10 bar) up to 100°F (38°C)* 0-50 psi (0-3 bar) at 140°F (60°C)	32-140°F (0-60°C)*		
Flow Switch Manifold (High Pressure)	0-300 psi (0-21 bar)*	32-158°F (0-70°C)*	Carbon Steel, Brass, 316SS, FKM	3/4" NPTF
Little Dipper 2	0-100 psi (0-7 bar)*	32-122°F (0-50°C)*	PVC, GRFPP, FKM	3/4" NPTF in-line tee
Pyxis	0-100 psi (0-7 bar)*	40-104°F (4-40°C)*	CPVC, Quartz, FKM	3/4" NPTF in-line tee

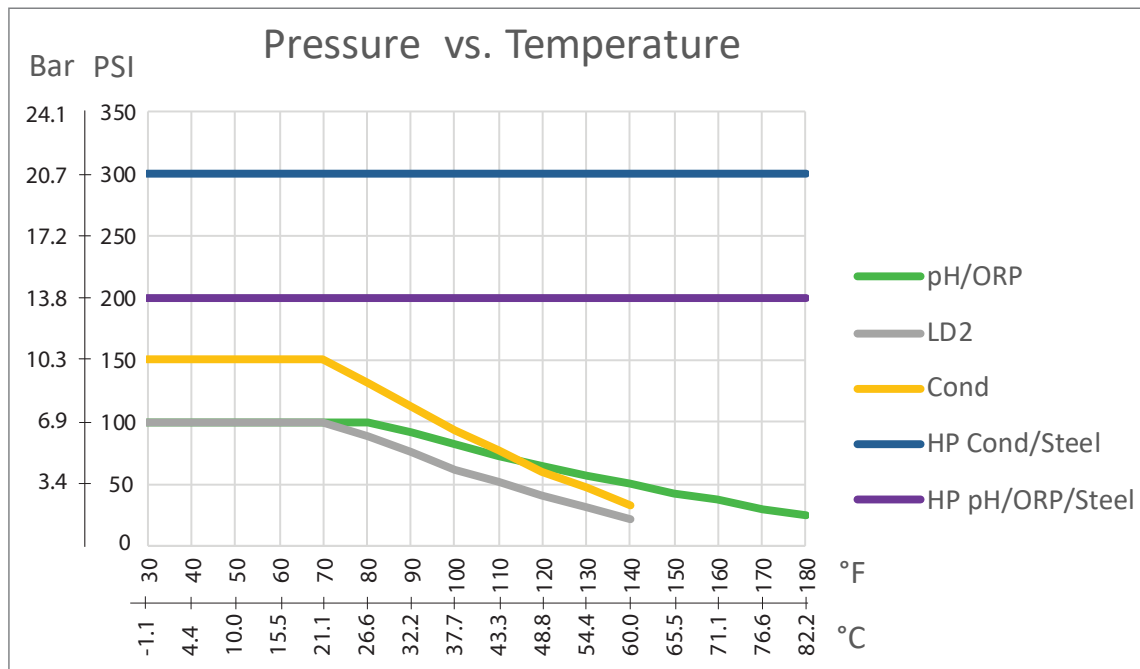



## ORDERING INFORMATION

WBL6  
WCT6  
WPH6  
WDS6  
WCN6

RELAYS/WIRING	POWER CORD	INPUT BOARD	ANALOG OUTPUTS	ETHERNET	-	SENSOR MOUNTING	SENSORS
A00	P	AA	A	M		P	BDNN

### RELAYS/WIRING

000	6 powered relays
100	2 powered 4 dry relays
200	2 opto 4 dry relays
400	4 opto 2 dry relays
A00	6 powered relays with USA pigtailed prewired
B00	2 powered relays with USA pigtailed prewired, 4 dry relays
C00	2 opto relays with 20 ft. pulse cables, 4 dry relays
D00	4 opto relays with 20 ft. pulse cables, 2 dry relays

### POWER CORD

B	Brazil power cord
D	DIN power cord
H	Hardwired - No power cord
P	USA power cord

### INPUT BOARD (Choose 2 in alphabetical order)

A	One sensor input board
B	One dual analog input board
C	One combination sensor/analog input board
N	No sensor input board

### ANALOG OUTPUTS

N	No analog outputs
A	One dual isolated analog output card

### ETHERNET

N	No Ethernet
E	Ethernet board
M	Ethernet board with modbus TCP + BACnet

### WCT,WPH, SENSOR MOUNTING

N	No Flow Switch, No mounting hardware, No Sensors
S	No Flow Switch, Submersion Sensors, 20 foot cables
I	No Flow Switch, Inline Sensors, 20 foot cables
L	Loose Flow Switch Manifold, 20 foot cables, Low Pressure
P	Flow Switch Manifold on Panel, 3 foot cables, Low Pressure
F	Loose Flow Switch Manifold, 4 foot cable, High Pressure
H	Flow Switch Manifold on Panel, 4 foot cables, High Pressure

### WDS SENSOR MOUNTING

N	No Flow Switch, No mounting hardware, No Sensors
I	No Flow Switch, Inline Sensors, 20 foot cables
L	Loose Flow Switch Manifold, 20 foot cables, Low Pressure
P	Flow Switch Manifold on Panel, 3 foot cables, Low Pressure

### WCN SENSOR MOUNTING

N	No Flow Switch, No mounting hardware, No Sensors
S	No Flow Switch, Submersion Sensors
I	No Flow Switch, Inline Sensors

### WBL SENSOR MOUNTING

NOT APPLICABLE SEE SENSOR OPTIONS

# ORDERING INFORMATION

WBL6  
WCT6  
WPH6  
WDS6  
WCN6

RELAYS/WIRING	POWER CORD	INPUT BOARD	ANALOG OUTPUTS	ETHERNET	SENSOR MOUNTING	SENSORS
A00	P	AA	A	M	P	BDNN

WPH SENSORS (choose 4 in alphabetical order)		INPUT TYPE
A	External pH/ORP Preamplifier, no sensor*	SENSOR
B	Flat surface WEL pH, With Pt1000 ATC	SENSOR
C	Flat surface WEL pH, No ATC	SENSOR
D	Rod Style WEL ORP	SENSOR
E	Flat surface WEL ORP	SENSOR
F	Flat surface WEL pH, 4-20 mA	ANALOG
G	Rod Style WEL ORP, 4-20 mA	ANALOG
H	Flat surface WEL ORP, 4-20 mA	ANALOG
N	No Sensor	
X	Dual low pressure manifold**	

\* Order 102029 or 102963 electrodes separately. These sensors are allowed with high pressure manifold sensor mounting

\*\*Order WEL electrode(s) and Preamplifier housing(s) separately, for L or P mounting style only

WCT SENSORS (Choose 4 in alphabetical order, except N last)		INPUT TYPE
A	Graphite contacting conductivity	SENSOR
B	316SS contacting conductivity	SENSOR
C	Electrodeless conductivity***	SENSOR
D	High pressure contacting conductivity*	SENSOR
E	Graphite contacting conductivity for Makeup water, threaded mounting adapter	SENSOR
F	Flat surface WEL pH, No ATC	SENSOR
G	High pressure pH, No ATC*	SENSOR
H	Rod Style WEL ORP	SENSOR
I	Flat surface WEL ORP	SENSOR
J	High pressure ORP*	SENSOR
K	Free Chlorine, 20 ppm, extended pH range membrane-style**	SENSOR
L	Chlorine Dioxide 0-20 ppm mebrane-style**	SENSOR
M	Little Dipper 2, 0-200 ppb PTSA**	ANALOG
N	No Sensor	
P	Pyxis PTSA**	ANALOG
S	Disinfection, membrane-style, No Sensor	SENSOR
T	Pyxis Tagged Polymer	ANALOG
U	Pyxis PTSA + Tagged Polymer	ANALOG
V	Flat surface WEL pH, 4-20 mA	ANALOG
W	Rod Style WEL ORP, 4-20 mA	ANALOG
X	Flat surface WEL ORP, 4-20 mA	ANALOG

\* If a high pressure manifold for H is selected, only Hi P Sensors and Makeup available.

\*\* Dipper, Pyxis, Chlorine, ClO2, Disinfection Sensors NOT available with Submersion mounting.

\*\*\*Requires "A" Sensor Input, will not work with the "C" combination board

WDS SENSORS (choose 2 in alphabetical order)		INPUT TYPE
A	Free chlorine, 0-20 ppm	SENSOR
B	ClO2, 0-20 ppm	SENSOR
C	Ozone, 0-20 ppm	SENSOR
D	PAA, 0-2000 ppm	SENSOR
E	Extended pH range free chlorine, 0-20 ppm	SENSOR
F	Total chlorine, 0-20 ppm	SENSOR
G	Peroxide, 0-2000 ppm	SENSOR
H	Stabilized Bromine, 0-20 ppm	SENSOR
I	Chlorite, 0-2 ppm	SENSOR
J	Chlorine, for use in absence of chlorine, 0-2 ppm	SENSOR
N	No Sensor	
X	DIS membrane-style manifold plus pH/ORP/cooling tower conductivity tee*	

\*Order disinfection sensor and WEL electrode and Preamplifier housing or cooling tower conductivity sensor separately, for L or P mounting style only

WCN SENSORS (Choose 2 in alphabetical order)		INPUT TYPE
A	PEEK electrodeless conductivity, 20 ft cable	SENSOR*
B	CPVC electrodeless conductivity, 20 ft cable	SENSOR*
C	Contacting conductivity, 1.0 cell constant, 100 psi, 10 ft cable	SENSOR
D	Contacting conductivity, 0.1 cell constant, 100 psi, 10 ft cable	SENSOR
E	Contacting conductivity, 10.0 cell constant, 100 psi, 10 ft cable	SENSOR
F	Contacting conductivity, 0.01 cell constant, 100 psi, 10 ft cable	SENSOR
G	Contacting conductivity, 1.0 cell constant, 200 psi, 10 ft cable	SENSOR
H	Contacting conductivity, 0.1 cell constant, 200 psi, 10 ft cable	SENSOR
I	Contacting conductivity, 10.0 cell constant, 200 psi, 10 ft cable	SENSOR
J	Contacting conductivity, 0.01 cell constant, 200 psi, 10 ft cable	SENSOR
N	No Sensor	

\*Requires "A" Sensor Input, will not work with the "C" combination board

WBL SENSORS (Choose 2 in alphabetical order)		INPUT TYPE
A	Boiler Sensor with ATC, 250 psi, 1.0 cell constant, 20 ft. cable	SENSOR
B	Boiler Sensor without ATC, 250 psi, 1.0 cell constant, 20 ft. cable	SENSOR
C	Condensate Sensor with ATC, 200 psi, 0.1 cell constant, 10 ft. cable	SENSOR
D	Boiler Sensor with ATC, 250 psi, 10 cell constant, 20 ft. cable	SENSOR
N	No Sensor	

# Cloud-based water treatment management software tool that amplifies the value of Walchem controllers



## Key Benefits

- Real-Time Access to Your Process
- Mobile Device Friendly
- Alarm Notification with Escalation
- Data Graphing and Storage

## Customer + Facilities Management

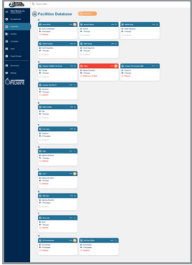

- Full management of customers and their facilities to access the information you need as quickly as possible
- Flag priority customers and facilities for quick access to help plan your upcoming work week

- Anywhere access to customer's real-time controller data
- Link directly to LiveConnect to make changes on your controllers remotely

## Process Monitoring + Control

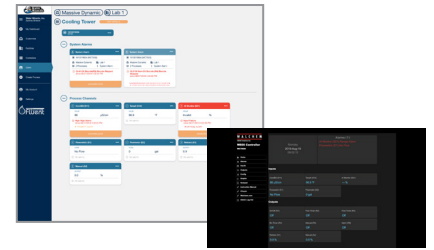

## Data Management + Visualizations



- Assess key parameters at-a-glance with customizable dashboard
- Easy-access to alarms organized by priority levels with acknowledgment features
- Bookmark customers, facilities and controllers for a user-customized dashboard experience
- Visualize recent and historical controller data trends on easy-to-read, interactive graphs
- Compare graphs across multiple controller channels
- Access historical data and export your graphs to PDF and CSV file for your reporting needs

## Alarms + Custom Notifications

- Manage workflow by notifying workers of triggered alarms
- Customize the escalation process including first party notified
- Notify two unique groups of users
- Manage alarm settings by controller channel
- Set alarm levels to quickly identify the most critical issues
- Alarm email summaries

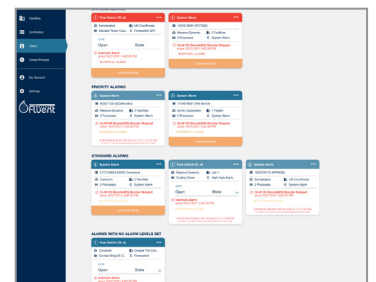

## Team Management

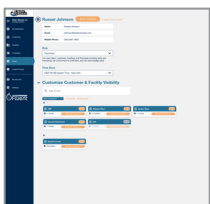

- Create admin, technician, and view-only user roles
- Set custom visibility permissions for users so they only see the customers they need to access

# SENSORS + ACCESSORIES

## High quality accessories for cooling tower, boiler, potable water, and wastewater applications

Carefully designed accessories and selected for compatibility with our pumps and controllers to enable our customers to provide a complete system solution. Here is just a sampling of the sensors and accessories available from Walchem:

### Disinfection Sensors

Amperometric disinfection sensors offer a cost effective and reliable solution to your disinfection control requirements. We offer sensors, in varying ranges of concentration, for free chlorine/bromine, total chlorine, chlorine dioxide, ozone, peracetic acid and hydrogen peroxide. Whether the application is cooling tower, food and beverage, drinking water, wastewater or swimming pool, these sensors are the ideal solution.

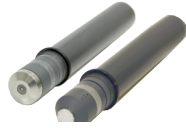

### Fluorometers

The Little Dipper 2 and Pyxis in-line fluorometers are rugged, 24/7 sampling devices that provide maximum performance, minimal maintenance and solid state reliability. They can be used with data collection systems to monitor and control the level of treatment chemicals for cooling tower and boiler applications. The handheld Little Dipper is a small, lightweight and highly durable fluorometer ideal for quick measurements in the field.



### Contacting Conductivity Sensors

Contacting conductivity sensors are ideal for use in cooling towers and boilers, reverse osmosis equipment, and other non-oily applications. A variety of cell constants are available to handle a range of conductivities.



### pH/ORP Sensors

Cost-effective differential pH/ORP electrodes for industrial and municipal applications.



### Electrodeless Conductivity Sensors

Electrodeless conductivity sensors may be installed in a variety of very harsh chemical control applications, including oily cleaner baths, chromates, rinse tanks, fume scrubbers and other concentrated chemicals up to a conductivity of 1000 mS/cm (range varies with solution temperature).



### Water Meters

WFM Series water meters have earned a reputation for design simplicity, wide range of applications and accuracy in low-quality water. The WFM Series uses the widely recognized multi-jet principle, which has been accepted as an international standard for many years. These meters are available with either a two-wire reed switch, or a solid state, three-wire Hall effect sensor.



### Metering Pumps

The E-Class is the most innovative and comprehensive metering pump product line in the world. Over 60 years of pump experience and a commitment to superior mechanical design has led to development of many industry firsts, including 360 stroke-per-minute technology, and the world's highest capacity solenoid metering pumps.



### Accessories

To complete your system, Walchem provides high quality accessories that are required for cooling tower, boiler, potable water, and wastewater applications. All of Walchem's accessories are carefully designed and selected for compatibility with our pumps and controllers to enable our customers to provide a complete system solution.



## ABOUT US

Walchem integrates its advanced sensing, instrumentation, fluid pumping and communications technologies to deliver reliable and innovative solutions to the global water treatment market. Our in-house engineering is driven by quality, technology and innovation. For more information on the entire Walchem product line, visit: [www.walchem.com](http://www.walchem.com)



ISO 9001 registered company

P/N 180904.C April 2023

**Walchem, Iwaki America Inc.**

Five Boynton Road Hopping Brook Park | Holliston, MA 01746 USA | Phone 508-429-1110 | [walchem.com](http://walchem.com)